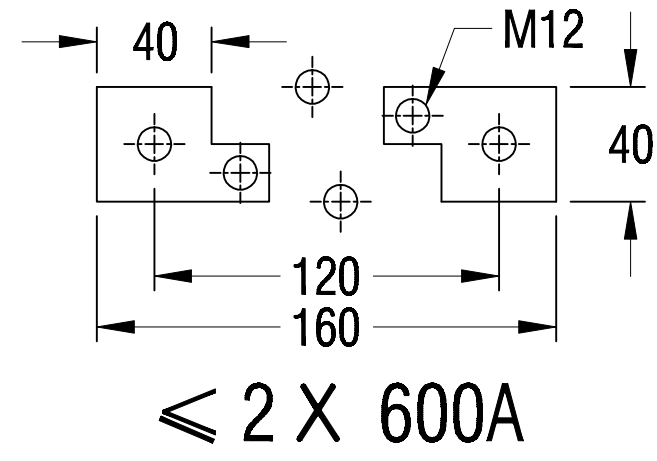

FIG: TOP VIEW



Description	
1.	Terminal Box
2.	PG Clamp
3.	Base Plate
4.	Grounding Bolt

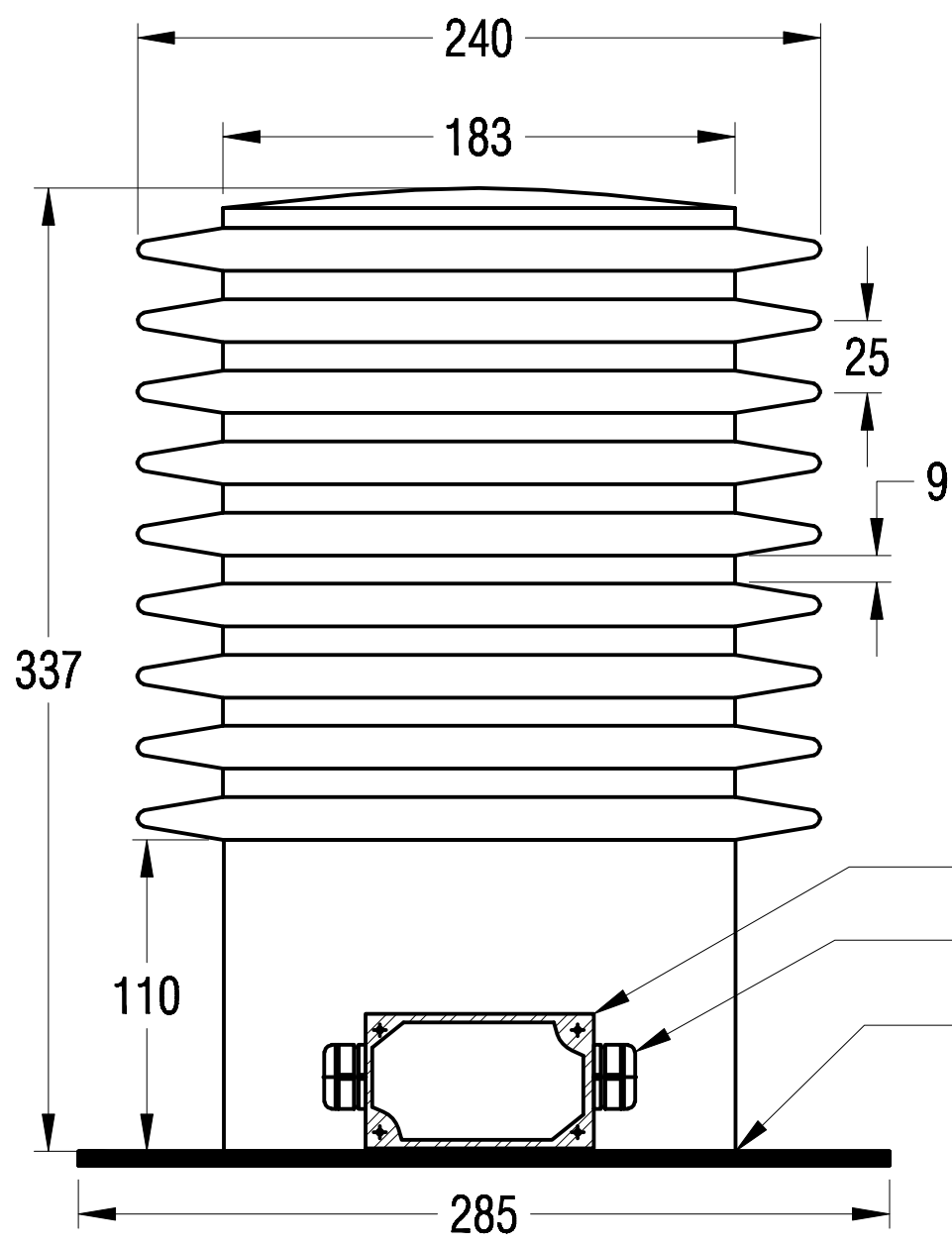

FIG: FRONT VIEW

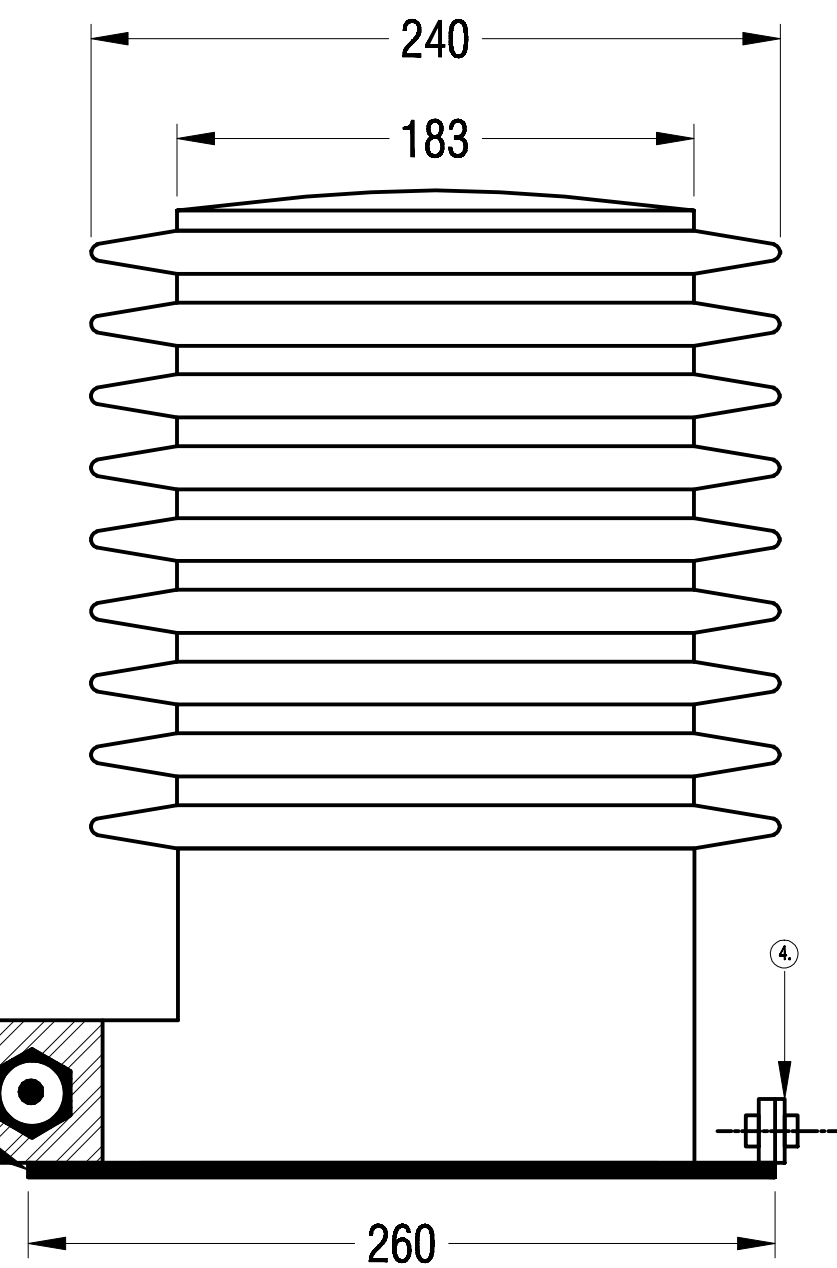



FIG: SIDE VIEW

FIG: GROSS AREA DRAWING OF G-23 CT

ALL DIMENSIONS TOLERANCE IS  $\pm 5\%$

TITLE OF DRAWING		MANUFACTURER	ITEM NAME	
TENDER NAME		 <b>VICAR ELECTRICALS LIMITED</b> LOHAGAS, SREEPUR, GAZIPUR, BANGLADESH.	MODEL NO.	CT11-1
DESIGNED BY			DRAWING NO.	
CHECKED BY			SCALE	
APPROVED BY			DATE	